

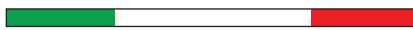

DRY MAX UV

ECO-JET DRYERS

ASCIUGAMANI - HAND DRYERS - SÈCHE-MAINS



MADE IN ITALY



191 - 300 Km/h



225 - 1000 W



Anti-covid
tested filter



 **VELOCITÀ ed EFFICACIA**
Tempo di asciugatura super veloce in 15 sec.



 **ULTRA - FAST DRYING TIME**
High speed hand dryer, drying time 15 sec.

 **RAPIDITÉ ET EFFICACITÉ**
Temps de séchage ultra rapide en 15 secondes

 **EFFICIENZA ENERGETICA**
Massimo risparmio energetico, consumi variabili da 225 W a 1000 W *



* 225 W con resistenza spenta e variatore al minimo - 1000 W con resistenza accesa e variatore al massimo

 **ENERGY EFFICIENCY**
Energy efficient hand dryer, rated power minimum 225 W - maximum 1000 W *

* 225 W heating element OFF and variator minimum level - 1000 W heating element ON and variator maximum level

 **EFFICACITÉ ÉNERGÉTIQUE**
Économie d'énergie maximale, consommation variable de 225 W à 1000 W *

* 225 W avec résistance désactivée et variateur au minimum - 1000 W avec résistance activée et variateur au maximum

 **IGIENE e SICUREZZA**
Igiene garantita dalla filtrazione dell'aria e dalla sanificazione dei componenti interni



 **HYGIENE and SAFETY**
Engineered for hygienic performance, air flow filtering and UV-C disinfection (24/7)

 **HYGIÈNE ET SÉCURITÉ**
Hygiène garantie par la filtration de l'air et la désinfection des composants internes

 **COMFORT e SILENZIOSITÀ**
Variatore per la regolazione della potenza e della rumorosità



 **NOISELESS**
Adjustable energy consumption, noise level and drying time

 **CONFORT**
Variateur pour la régulation de la puissance et du bruit

 **DESIGN COMPATTO ED ELEGANTE**
Minimo ingombro, profondità inferiore a 10 cm.

 **STYLISH AND COMPACT DESIGN**
Very compact in size, depth less than 10 cm.

 **DESIGN COMPACT ET ÉLÉGANT**
Taille très compacte, profondeur inférieure à 10 cm.

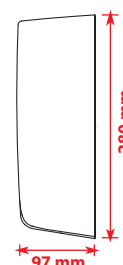

 **ARTICOLI & CODICI PRODOTTI**



 **MODEL REFERENCE CHART**

 **TABLEAU DES MODÈLE DE RÉFÉRENCE**



Cod.

DRY MAX UV BF	ABS bianco / white ABS / ABS blanc
DRY MAX UV SF	ABS satinato / satin ABS / ABS satiné
DRY MAX UV LF	ABS lucido / chromed ABS / ABS brillant
DRY MAX UV NF	ABS nero / black ABS / ABS noir



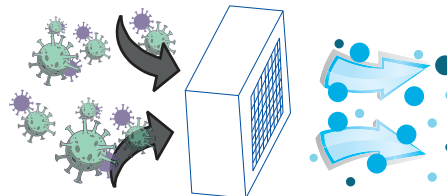

-  **FILTRO EPA E11**
Filtro con efficacia antivirale / antibatterica incluso
-  **EPA FILTER E11**
Antiviral and antibacterial filter included
-  **FILTRE EPA E11**
Filtre efficacement antiviral / antibactérien





-  **LAMPADA UVC**
per disinfezione del condotto di ventilazione
-  **UVC LAMP**
for internal parts disinfection
-  **LAMPADE UVC**
pour disinfection de la chambre d-air

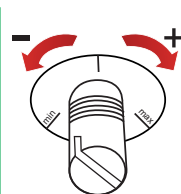

-  **RESISTENZA ON-OFF**
-  **HEATING ON-OFF**
-  **CHAUFFAGE ON-OFF**



-  **VARIATORE**
per regolazione di potenza e rumorosità
-  **VARIABLE SPEED**
adjustable energy consumption, noise level and drying time
-  **VARIATEUR**
pour réguler la puissance et le bruit du moteur





ASCIUGAMANI - HAND DRYERS - SÈCHE-MAINS

- CONFRONTO COSTI DI ASCIUGATURA ANNUALI
- ANNUAL SAVINGS CALCULATIONS
- CALCULEZ VOS COÛTS/ECONOMIES ANNUELLES

N° UTILIZZI GIORNALIERI DAILY USE UTILISATION PAR JOUR	 1000 W	CARTA PAPER PAPIER	COTONE COTTON COTON	 2400 W
100	€ 43,22/anno	€ 876,00	€ 744,60	€ 250,35
200	€ 86,43/anno	€ 1.752,00	€ 1.489,20	€ 500,71
400	€ 172,87/anno	€ 3.504,00	€ 2.978,40	€ 1.001,41



Calcoli basati su 365 giorni/anno. Costo dell'energia 0,361 €/kWh. Costo salvietta di carta monouso € 0,008, con una media di 3 salviette per asciugatura. Costo asciugatura con rotolo di cotone € 0,0204 (escluso canone dispenser).



Counts are based on 365 days per year. Energy cost 0,361 €/kWh. The average cost of a paper towel is € 0,008 (3 paper towel sheets per user). The average cost of a cotton towel is € 0,0204 (dispenser fee excluded).



Calculs basés sur 365 jours/an. Coût énergétique de 0,361 €/kWh. Les serviettes en papier jetables coûtent € 0,008 avec une moyenne de 3 lingettes par séchage. Coût du serviettes en coton de € 0,0204 (frais de location du distributeur exclus).

CARATTERISTICHE TECNICHE / TECHNICAL FEATURES / CARACTÉRISTIQUES TECHNIQUES

Funzionamento	Sensore di rilevam. elettronico a raggi infrarossi
Functioning	Sensor operating
Activation	Capteur électronique
Giri al minuto	
Tr min	12.000 - 24.000 rpm
Révolutions par minute	
Grado di protezione elettrica	
Electrical Protection Level	IP33 - CLASS II
Isolation électrique	
Tensione	
Supply Voltage	220 V-240 V
Tension d'alimentation	
Potenza totale	
Total power	225 - 1000 W
Puissance totale	
Potenza resistenza	
Absorption Heating Element	0 - 500 W (ON-OFF)
Puissance chauffage	
Potenza motore	
Absorption Motor	225 - 500 W
Puissance moteur	
Dimensioni A x L x P	
Dimensions H x W x D	280 X 180 X 97 mm
Dimensions H x L x P	
Frequenza	
Frequency	50-60 Hz
Fréquence	
Velocità aria	
Air Speed	191 - 300 km/h
Vitesse d'air	

Volume aria	
Air flow	max 120 mc/h
Débit d'air	
Peso	
Weight	1,86 Kg
Poids net	
Materiale	
Materials	ABS
Matériel	
Marchi di qualità	
Quality marks - certifications	CE - ROHS
Certification	
Rumorosità (2m)	
Noise level (2m)	68 - 75 db
Niveau sonore (2m)	
Garanzia	3 anni
Warranty	3 years
Garantie	3 ans

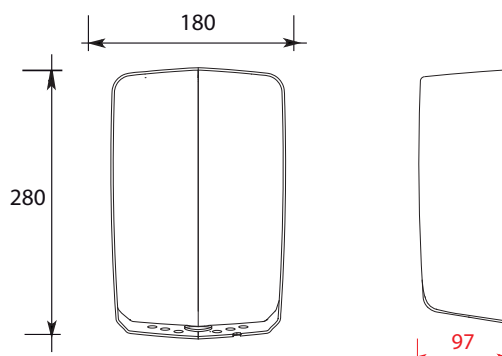

Per le limitazioni di garanzia si vedano le condizioni generali di servizio

Limited warranty. Please have a look to the General Warranty Conditions for details and consumable

Limitations de garantie: revoir Conditions de Garantie Generale